

**THE G ARMS & OPTIONS**

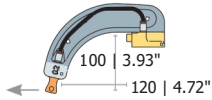

**G2- 8bar/300 daN**  
022775 116 psi / 674.42 lbf

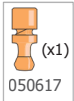
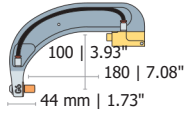

**G6- 8bar/550 daN**  
022812 116 psi / 1,236 lbf

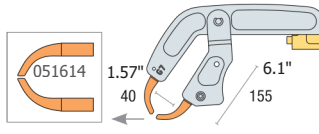

**G7- 4bar/150 daN**  
022829 58 psi / 337 lbf

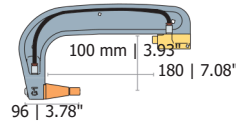

**G1- 8bar/550 daN**  
022768 116 psi / 1,236 lbf

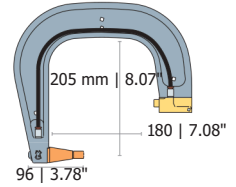

**G3- 8bar/550 daN**  
022782 116 psi / 1,236 lbf

**G1/G3-SA (Small Access)**

067653



63 mm | 2.48" 134 mm | 5.27"

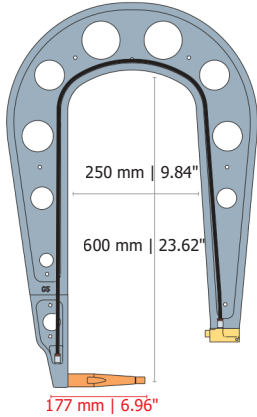

**G5- 8bar/550 daN**  
022805 116 psi / 1,236 lbf

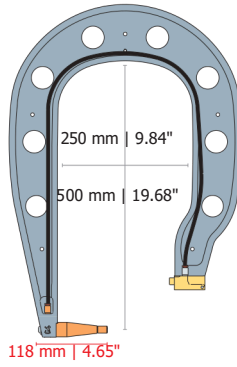

**G4- 8bar/550 daN**  
022799 116 psi / 1,236 lbf

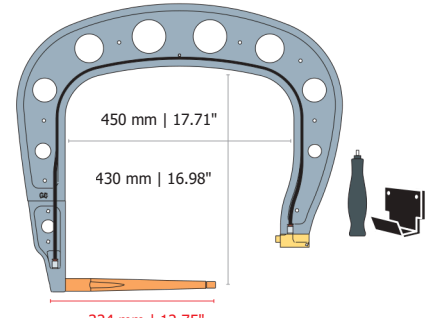

**G8- 8bar/550 daN**  
022836 116 psi / 1,236 lbf

**G4-SA (Small Access)**

064478



63 mm | 2.48" 156 mm | 6.14"

**G8-SA (Small Access)**

067677



63 mm | 2.48" 362 mm | 14.25"

**The small access:**

(SA) electrodes resolve common accessibility issues with certain areas of the car body

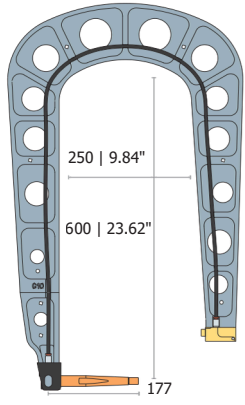

**G10- 8 bar/400 daN**  
067165 116 psi / 900 lbf

lighten

**G5-G10-SA (Small Access)**

067660



63 mm | 2.48" 215 mm | 8.46"

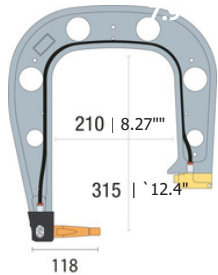

**G14- 8 bar/550 daN**  
080942 116 psi / 1,236 lbf

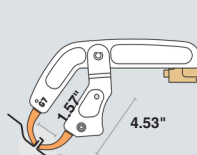

**G7**  
58PSI / 150 daN

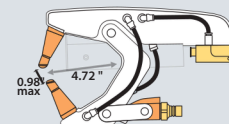

**G11**  
116PSI / 550 daN  
Compatible with PTI NEO

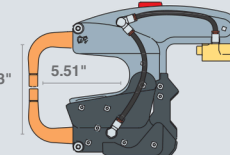

**G9**  
116PSI / 500 daN  
For PTIMASTER and PTI EXPERT  
(not compatible with PTI NEO)



Options for G9

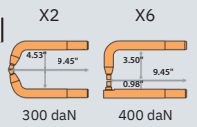

X2 300 daN X6 400 daN

**Option G10/G12-SA (Small Access)**

067660



**G12- 8bar/300 daN**  
075238 116 psi / 674.42 lbf

